

**MASTEEL FABRICATING EQUIPMENT**

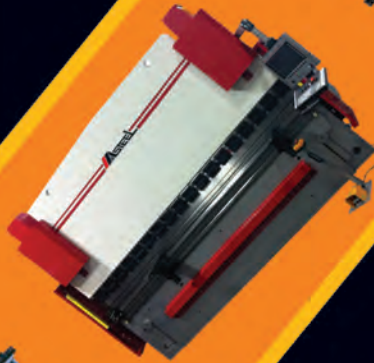

**MASTEEL FABRICATING EQUIPMENT**



**MASTEEL REPRESENTS**

**QUALITY, CAPABILITY AND AFFORDABILITY**

**WELL BUILT and VALUE PRICED**

# MODERN WELL-EQUIPT MANUFACTURING FACILITIES



**MASTEEL FACILITY IN CANADA**



**MASTEEL MANUFACTURING FACILITY**



30 Ft G&L Horizontal Boring Mill provides greater capability for machining of large welded and stress-relieved structure ensuring highest degree of accuracy



MODERN FACILITY

01

SOLID FIRST CLASS

ENGINEERING

MODERN FACILITY

02

# MBHS SERIES HYDRAULIC SYNCHRONIZED CNC BRAKES

**STANDARD CONTROL FEATURES:**

- Standard KV-2004 CNC control with 11" TFT screen and graphical display
- 0.0004" high resolution linear scales provide precision dual ram position feedback.
- Bosch-Rexroth Closed-loop Proportional Hydraulic position control: repeatability at  $\pm 0.0004$ " and parallelism at  $\pm 0.0004$ "
- Y1, Y2 Programmable independently in angle or position.
- Ram tilt adjustment at  $\pm 0.5$ "
- Hydraulically Synchronized ram parallelism control compensates uneven force on the bend by means of hydro-electrical technique.
- Programmable ram delay control at bending position under adjustable pressure
- Servo CNC back gauge with precision ball screw and double linear guide way ensures unsurpassed rigidity and high productivity speed.
- Back gauge position speed at 1000 IPM, repeatability at  $\pm 0.001$ "
- Automatic or programmable back gauge retract feature.
- Auto and programmable pressure control
- Programmable ram top stop and slow bending position
- Programmable bending speed
- Automatic conversion: Inch / mm
- Promecam punch clamping system with quick release on braked under less than 320Ton.



Standard Masteel KV-2004 CNC control



**MBHS - 20500 500Ton x 20'**  
with optional Hydraulic CNC Crowning

MASTEEL CNC BRAKE

MASTEEL CNC BRAKE

03

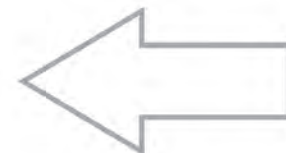
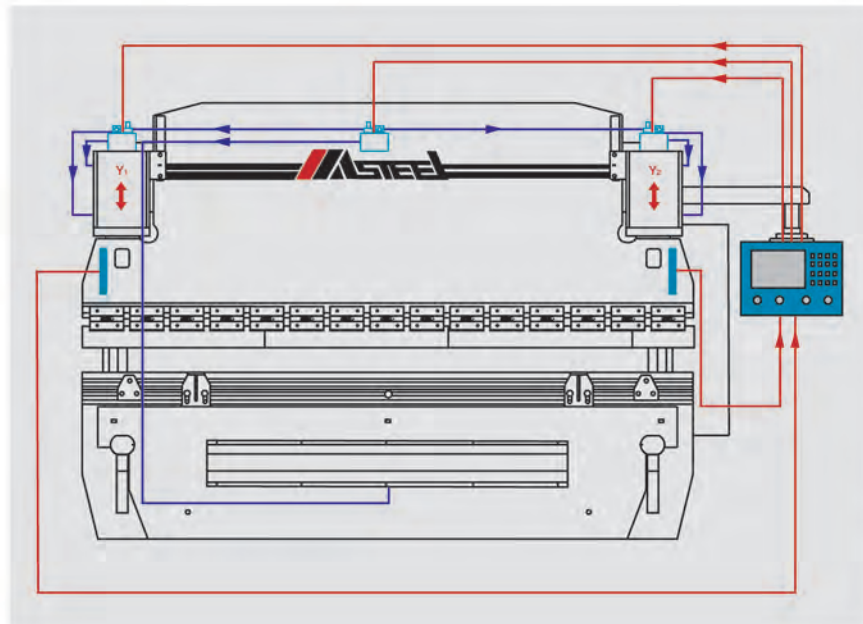

**STATE OF THE ART**  
HYDRO-ELECTRICAL COMPONENTS  
AND OPERATING CONTROL SYSTEM

04



MASTEEL REPRESENTS

QUALITY, CAPABILITY AND AFFORDABILITY

WELL BUILT and VALUE PRICED

# MBHS SERIES SERVO HYDRAULIC CNC BRAKES WELL-BUILT WITH QUALITY COMPONENTS

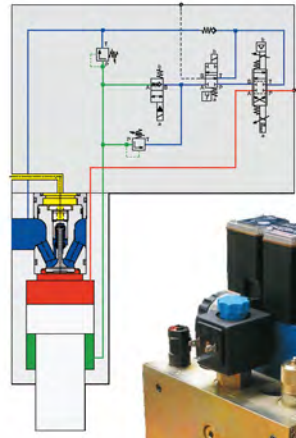

**Bosch-Rexroth Closed-loop Proportional Hydraulic position control**  
repeatability at  $\pm 0.0004''$  and parallelism at  $\pm 0.0004''$



05

**0.0004" high resolution linear scales**  
provide precision dual ram position feedback.



**MBHS - 14280 280Ton x 14'**  
with standard Hydraulic CNC Crowning



**Various Optional Tooling**  
American and European Tooling Packages

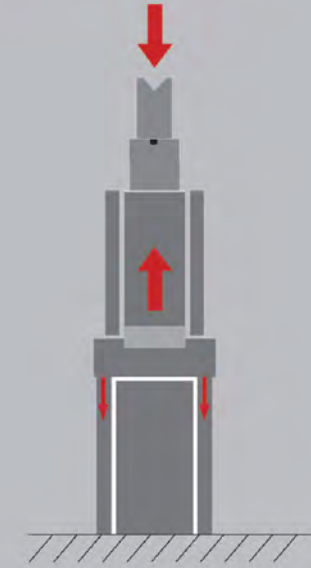

**Hydraulic CNC auto Crowning System**  
Crowning cylinder mounted in bed and provides automatic anti-deflection compensation correlated to tonnage

MASTEEL CNC BRAKE

06



**OPTIONAL DELEM DA-56    OPTIONAL DELEM DA-69W**



MASTEEL REPRESENTS

QUALITY, CAPABILITY AND AFFORDABILITY

WELL BUILT and VALUE PRICED

# MASTEEL CNC BACKGAUGE

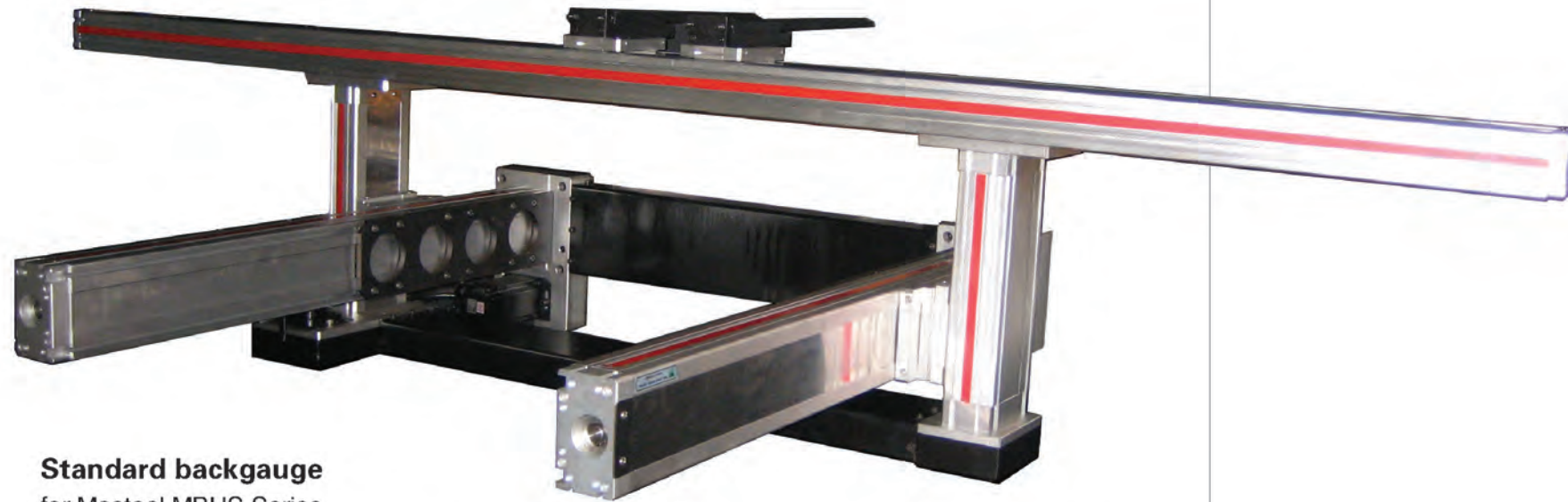

**Standard backgauge**  
for Masteel MBHS Series  
Hydraulic Synchronized CNC Brakes

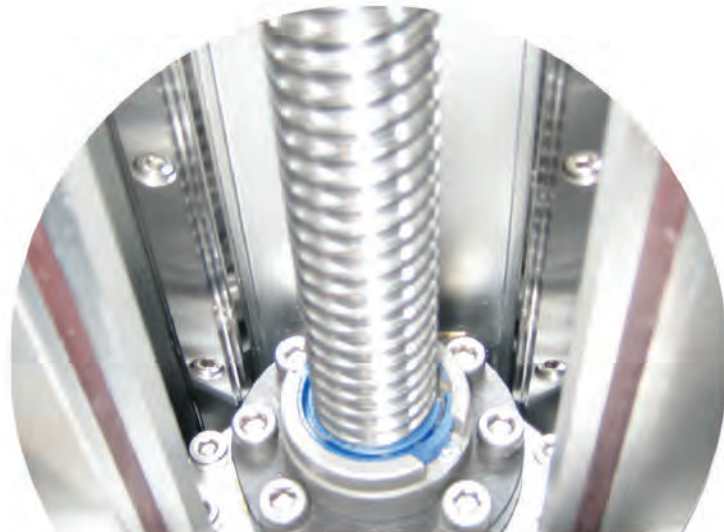

**Servo CNC back gauge with precision ball screw and double linear guide way ensures Maximum rigidity for high productivity speed and high accuracy:**

- Positioning Speed at 1000 IPM
- Repeatability Accuracy at  $\pm 0.001"$



**Backgauge Finger Control**  
Power control station for backgauge finger

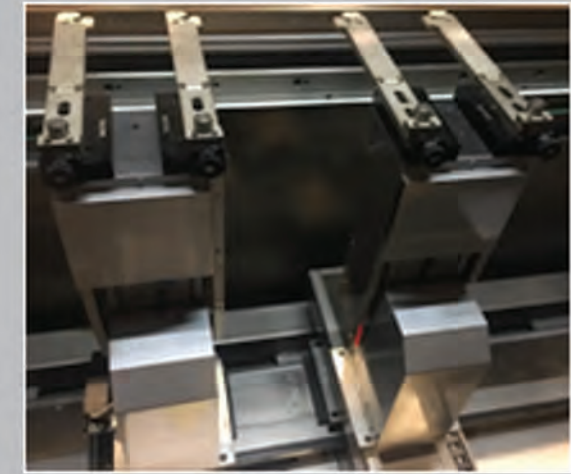

**Optional multi-axis configurations:**  
X1, X2, Z1, Z2, R1, R2  
allow up to six different movements  
to be automatically calculated and  
set by the control

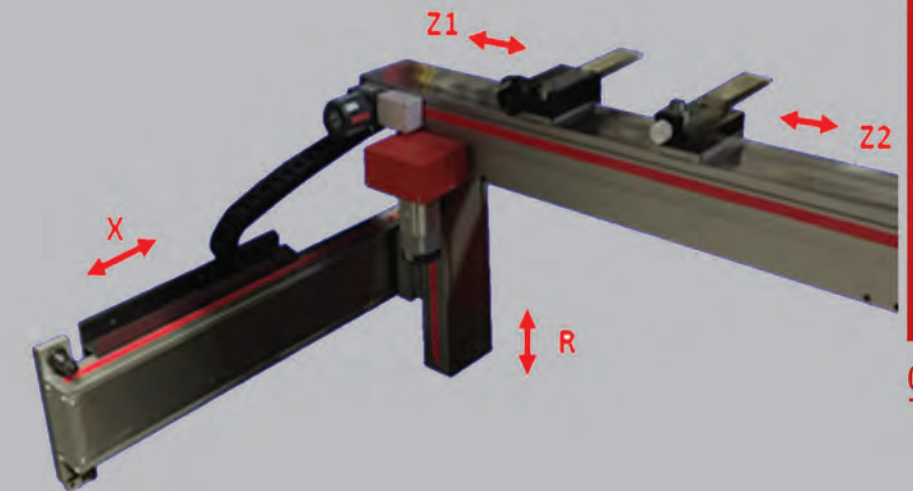

**Masteel Servo CNC Back Gauge**  
X, R, Z1, Z2 4 axis CNC control

MASTEEL CNC BRAKE

07

MASTEEL CNC BRAKE

08

# MASTEEL KV-2004 CONTROL FEATURES

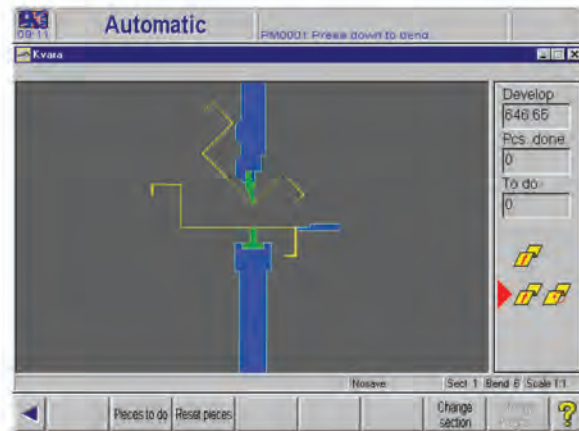

■ **Simulation and optimum bending sequence with back gauge position**

The optimized bending sequence can be simulated in the graphic window prior to the actual production of a part thereby avoiding costly damage or collisions.

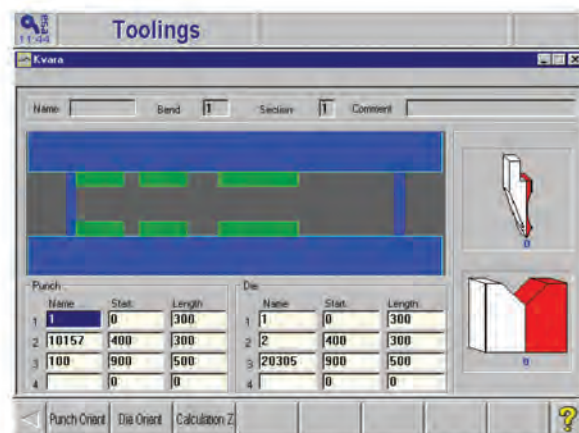

■ **4 tooling work stations in a program (across the bed)**

Excellent feature for various bending applications requiring different tooling setup within a single job under one program, no need to change program or re-set tooling



- Interactive 2D graphic editor for work piece, parts and tool data entries
- 2D graphic display of machine frame, backgauge finger, work-piece and tooling
- 2D graphic identification of optimum bending sequences
- Automatic calculation of crowning tonnage
- Automatically calculate back gauge position
- Automatically calculate material thickness and offset back gauge position according to the bend
- Optimum bend sequence
- Collision detection
- Up to 4 tooling stations in each program
- Machine set-up preparation for pre-drawing and testing new fixture
- Programmable Y1, Y2 by position and angle
- Unlimited tool memory
- Unlimited job memory
- Off-line programming system with similar user interface as CNC Control
- Off-line programming system 2D profile view and simulation
- Up and down load program and tooling data as well as machine parameters from floppy disk driver or optional USB port
- Print-out capabilities
- Keyboard interface adaptor
- Built in Ethernet internal communications port for up/down load from office
- Web enabled monitoring function for service, trouble shooting and data transfer

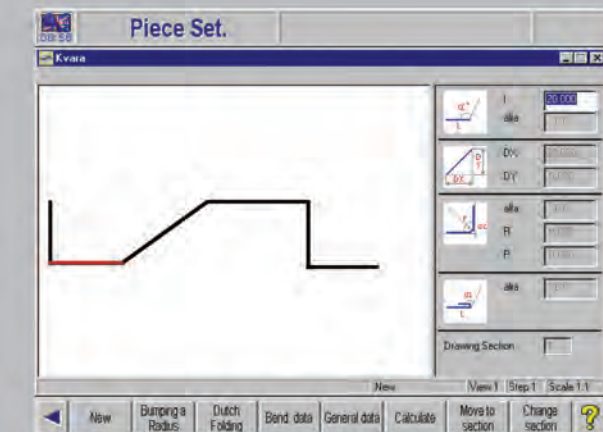

■ **Easily draw a work piece**

The cursor may be placed within the screen field to allow operator easy entry of desired angles and/or dimensions.

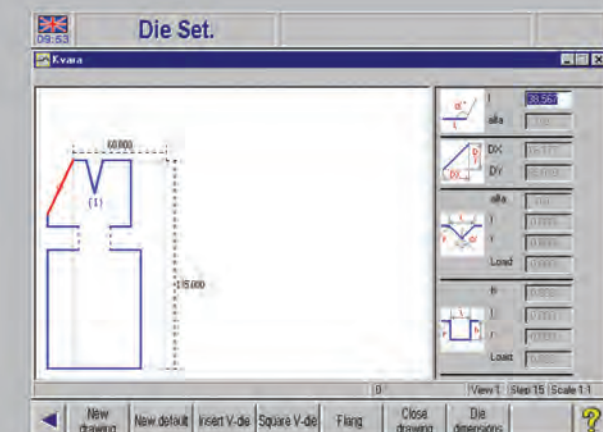

■ **Create tooling:**

New tooling may be tested in your bend sequence prior to ordering from your tool supplier – saving time & money. Create your own custom tooling when needed.

# MBHA SERIES HYDRAULIC SYNCHRONIZED CNC BRAKES



MASTEEL CNC BRAKE

11

**CONTROL FEATURES:**

- Standard SIEMENS TP-700 control with 7" touch screen display.
- SIEMENS CNC control with Y1/Y2/X/R/Z1/Z2 position control, R and Z1/Z2 axis as option.
- Ram bending position control – Y1/Y2 axis:
  - ▶ Y1, Y2 programmable independently in angle or position.
  - ▶ Ram tilt capacity at  $\pm 0.5^\circ$ .
  - ▶ Bosch-Rexroth closed-loop proportional hydraulic position control: repeatability at  $\pm 0.0006"$ .
- Servo driven back gauge position control:
  - ▶ Standard CNC back gauge: Speed at 400 IPM; Repeatability at  $\pm 0.003"$ .
  - ▶ Optional R axis CNC control.
  - ▶ Optional CNC Z1/Z2 axis or power operated Z1/Z2 axis.
  - ▶ Programmable back gauge retract feature.
  - ▶ 3-step finger position with automatic offset on X axis.
- Two way angle corrections - allow inexperienced operator to achieve desired angles without multiple test bends.
  - ▶ Input of the difference from desired angle to test bending, control will automatically adjust the bending position to achieve desired angle.
  - ▶ Adjust bending position with Y axis incremental per degree calculated by control system.
- Dual ram position feedback with hydraulic synchronized control allow bending at one end of brake for deep box
- Tool memory for quick recall of tool setup
- 200 job memory, with an average of 30 bends per program.
- Programmable tonnage control
- Programmable ram delay and programmable tonnage at the bending position for bump bending or heavy bending applications
- Automatic maintenance schedule reminders
- Operating prompts and troubleshooting messages
- Inch / MM conversion

MASTEEL CNC BRAKE

12

**OPERATING FUNCTION:**

- Ram speed control:
  - ▶ Rapid approach and return speed.
  - ▶ Slow bending speed for accuracy control.
  - ▶ Programmable bending speed.
- Ram stroke control:
  - ▶ Programmable ram top stop limit for more efficient production.
  - ▶ Programmable slow working speed position.
  - ▶ Programmable second stop position.
- Four Operating Modes:
  - ▶ Jog mode: Inching control of the ram for tool setup.
  - ▶ Single mode: One full bend cycle per control input.
  - ▶ Double stop mode: Ram stop above material and excellent for sight bend operations.
  - ▶ Follow bend mode: Ram jogging down/up with foot paddle and easy to follow bending and ram return on large sheets or with crane handling.



**MASTEEL REPRESENTS**

**QUALITY, CAPABILITY AND AFFORDABILITY**

**WELL BUILT and VALUE PRICED**

# VALUE AND QUALITY STANDARD EQUIPMENT FOR MASTEEL MBHA SERIES CNC BRAKE

- Hardened and precision ground tool steel gooseneck punch: 53-58RC; 100Ton/M (30Ton/Ft) capacity
- Hardened and precision ground Masteel 10 openings, 4-way die: HB190-260

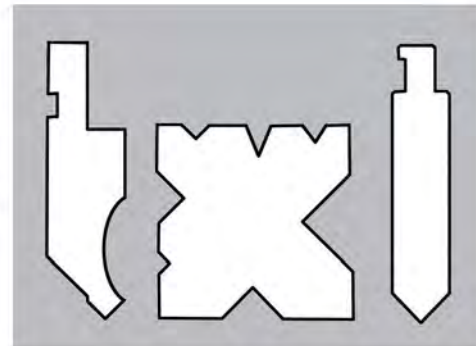

BOSCH-ROXROCH Hydraulic Valve Assy for MBHA Series CNC Brake



- American-made motors



- America-made hydraulics  
Simple hydraulic system for reliable performance
- Quality America-made components:  
Valves, pump, hoses and fittings

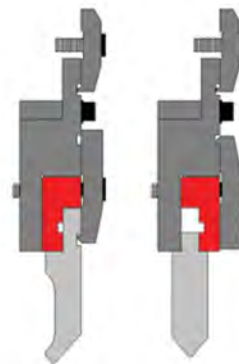

- Masteel special punch holders accept both American and European punches with no need of any ram adaptor.

- SIEMENS Compact Control System  
Siemens compact control system integrates CNC position control, hydraulics and electric control in one. Simple and uncluttered control component ensures years of quality performance on Masteel Brakes



MASTEEL CNC BRAKE

MASTEEL CNC BRAKE

13



- Fully equipped with Masteel Easily adjustable tooling and clamping system
- Versatile floating die clamping system
- Masteel Crowning punch holder
- Easily adjustable wear surface on the ram to maintain brake accuracy
- T-slotted bed for support arms or custom setups



Standard Front Sheet Support Arms

- Front support arm



Optional Quick-set Front Sheet Support Arms

14

- 12-3/4" throat depth with swing up clearance allows full length bend over bed up to 12" deep





# OPTIONAL EQUIPMENT AND TOOLING



■ **ROBOTIC INTERFACE**



■ **SAFETY LIGHT CURTAIN**



■ **LASER CHECK**  
**BENDING ANGLE MEASURING DEVICE**

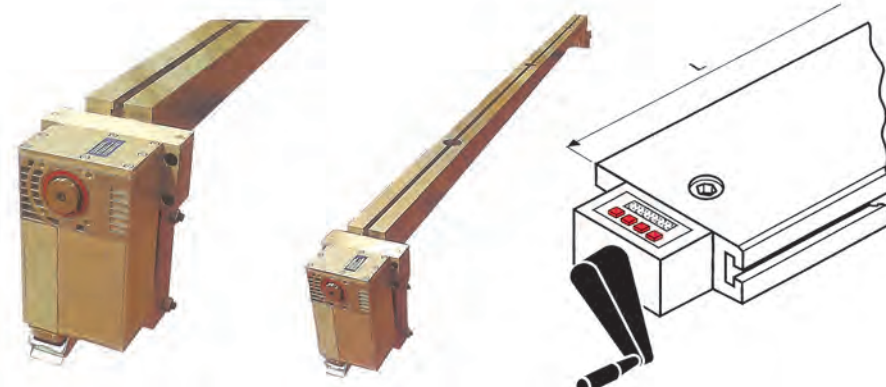

CNC DRIVE                      MANUAL DRIVE

■ **CROWNING DIE HOLDER**

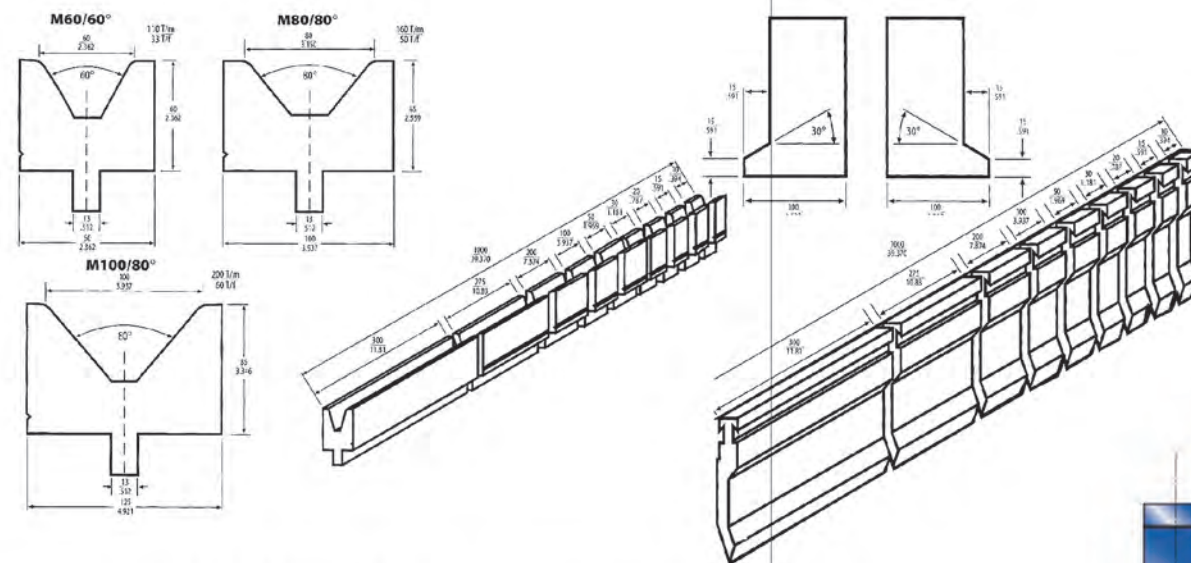

■ **BEYELER TYPE TOOLING**

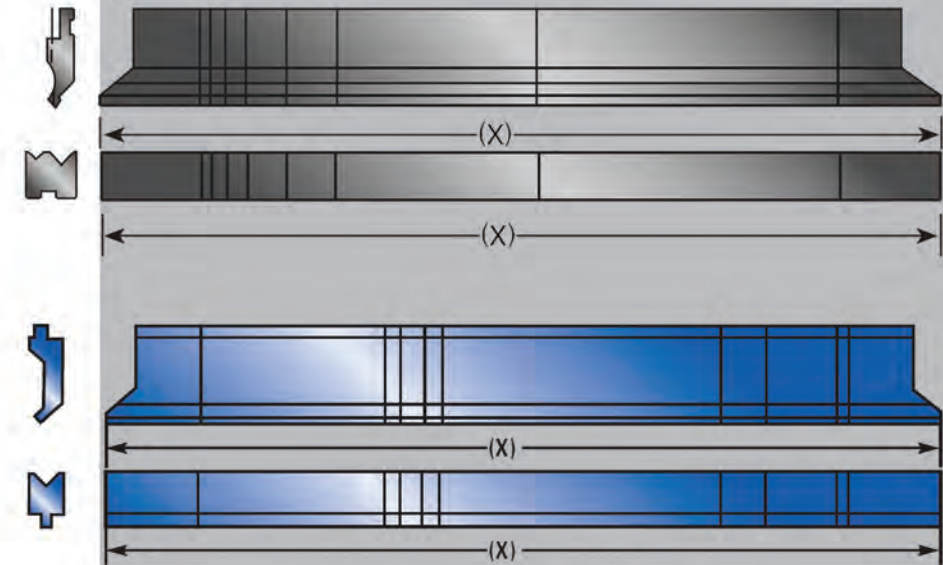

■ **AMERICAN AND EUROPEAN STYLE**  
**SEGMENTED PUNCH AND DIE**

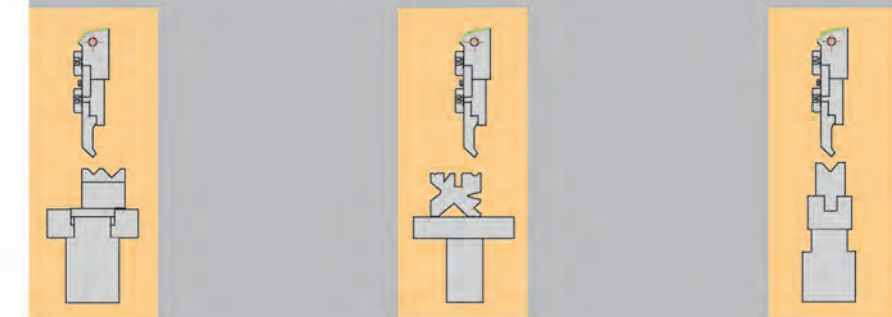

■ **OPTIONAL DIE HOLDE**



■ **OPTIONAL PUNCH HOLDE**



# MASTEEL CNC HYDRAULIC SWING BEAM SHEARS

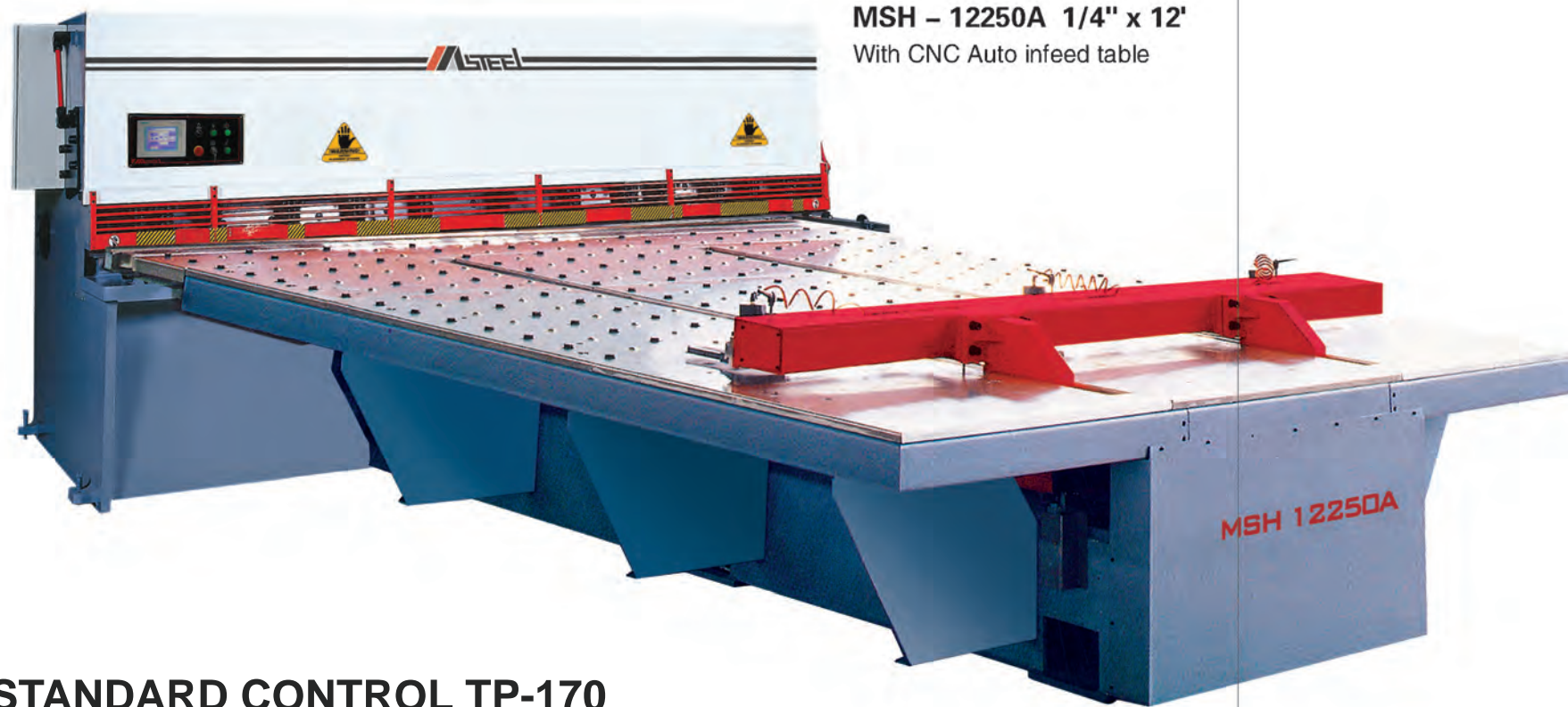

**MSH - 12250A 1/4" x 12'**  
 With CNC Auto infeed table



## STANDARD CONTROL TP-170

### CONTROL FEATURES:

- **Siemens CNC backgauge control.**
  - ▶ Programmable 100 cutting job memory and 10 steps each job.
  - ▶ Stroke counter control.
  - ▶ Cutting width control.
  - ▶ Accuracy at  $\pm 0.002"$ .
- **6" touch screen display.**
- **Numeric keyboard for easy data input.**
- **Simple easy operating control console with all the manual control functions on only one screen**
  - ▶ Backgauge position display in 0.001".
  - ▶ One-step go-to position control on backgauge.
  - ▶ Manual push button adjustment on backgauge.
  - ▶ Programmable backgauge retract function on each cutting step.
  - ▶ Numeric keypad for easy data input.
  - ▶ Operating hour meter.
  - ▶ Auto swing-up backgauge at full travel.
  - ▶ Programmable cutting width control.
  - ▶ Programmable cutting stroke control.
  - ▶ Prompting instructions for easy operation and service.
  - ▶ Running status display on control console.
 

Manual/Auto mode	Backgauge position
Cutting Width	Number of cutting strokes
  - ▶ Blade gap setup operator prompt at start up.

### OPERATING FUNCTION:

- **Steadily cutting speed and rapid back stroke for higher production efficiency.**
- **Multi-control mode**
  - ▶ Console push button or foot switch control.
  - ▶ Single cut / continue cut mode.
  - ▶ Multi-backgauge positioning and automatic multi-cut control mode.
- **Auto clamping pressure or padded holddown feet, auto-adjusted to material thickness.**
- **Complete hydraulic and electrical overload protection.**

MASTEEL CNC SHEAR

MASTEEL CNC SHEAR

## STANDARD CONTROL TP-170





MASTEEL REPRESENTS

QUALITY, CAPABILITY AND AFFORDABILITY

WELL BUILT and VALUE PRICED

# VALUE AND QUALITY STANDARD EQUIPMENT FOR MASTEEL CNC SHEAR

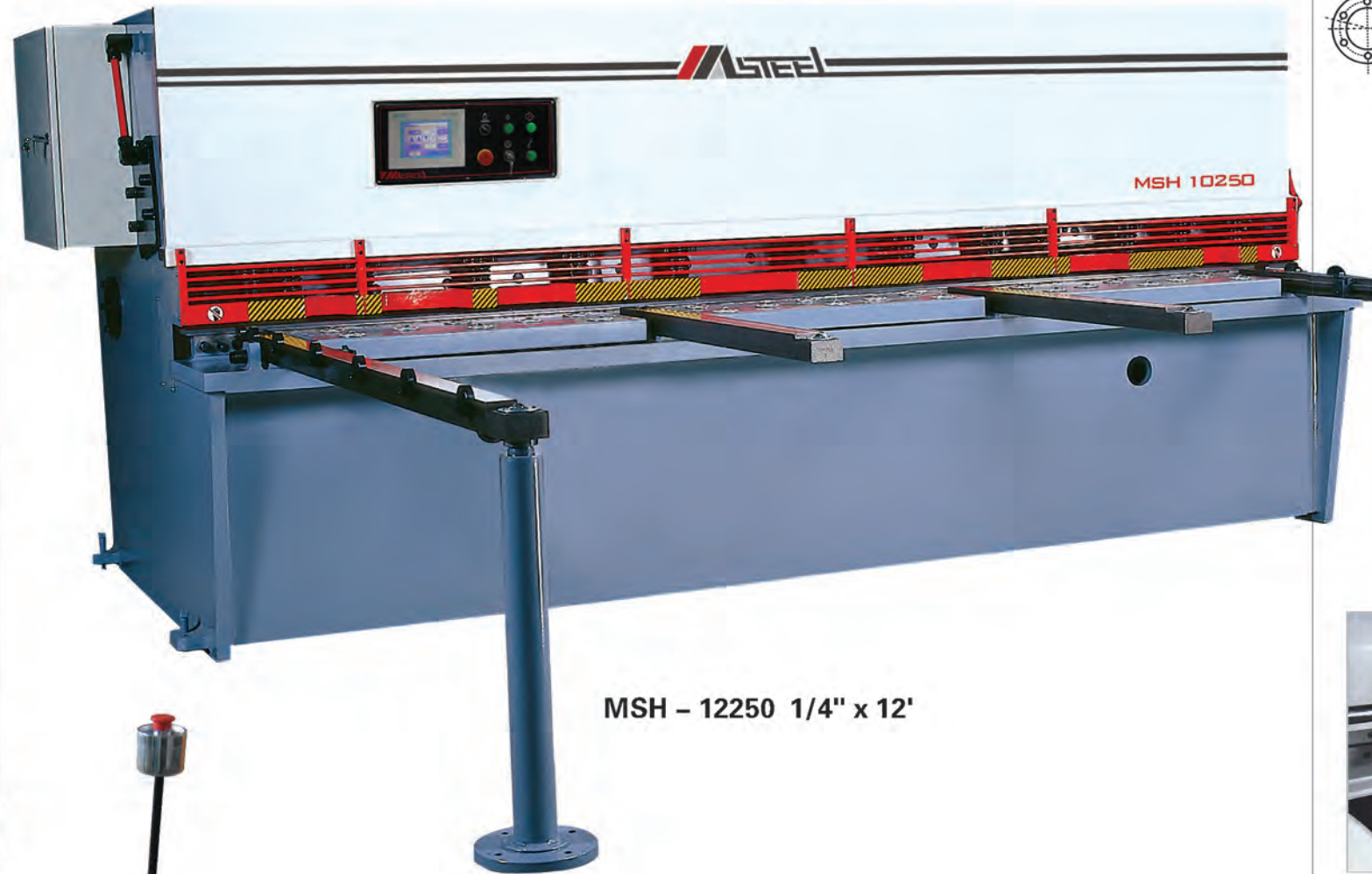

MSH - 12250 1/4" x 12'

MASTEEL CNC SHEAR

21

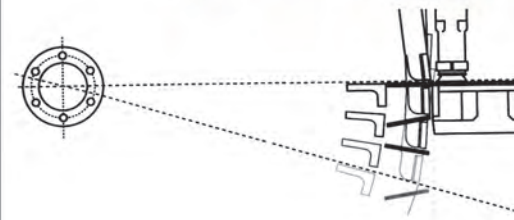

### ACCURACY

Top blade and back gauge swing together allowing the material to remain perpendicular to bottom blade then swing away from the bottom blade after the cut thereby preventing jamming of the material between the blade and the back gauge.

### RELIABILITY AND FUNCTIONABILITY

Masteel swing beam shears do not require a relief angle therefore the force created by the hydraulic cylinder is applied directly against cutting load. Cutting loads do not deflect the cutting blades or beam mechanism and therefore blade clearance gap remains consistent through the cut. This feature allows Masteel shears to cut strips narrower than the material thickness without damage to the blades or machine structure.

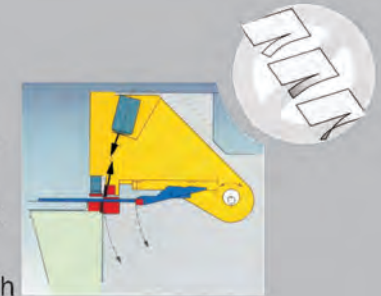

### QUALITY AND HEAVY-DUTY STRUCTURES

Mono-block type, welded frame and blade beam construction are optimized by computer-aided engineering to guarantee maximum rigidity. Heavy-duty taper roller bearings are located at swing beam centers so that cutting load is always perpendicular to blade beam rotational radius. This avoids cutting loads being transferred to the support bearings thereby insuring longer life and consequently better accuracy over the long term.



MASTEEL CNC SHEAR

22



**Movable pedestal with foot control switch and emergency stop**



**Independent holddowns** automatically adjust holddown-pressure to various material. More holddown-pressure for heavier cutting and less pressure for delicate thin material.

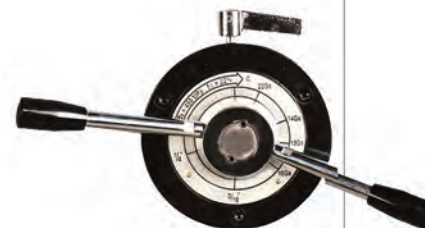

**Precision quick blade adjustment** ensures proper blade clearance, variable position to suit for material thickness and properties in order to achieve quality cutting



**American-made hydraulics** Simple hydraulic system for reliable performance Quality American-made components: Valves, pump, hoses and fittings



**Siemens Compact Control System** integrates CNC backgauge, hydraulics and electric control in one. Simple and less complicated control ensures years of quality performance on Masteel Shears

**STANDARD EQUIPMENT:**

- Two squaring arms c/w stainless steel rule (metric and standard scales) and disappearing stops
  - ▶ 7 Ft on left side to facilitate squaring of long sheet material
  - ▶ 4 Ft arm on right to provide even service life across full length of blades
- 4 Ft front support arms
- Ball transfers in table for ease of handling heavier materials
- Ball transfers on front support arms, front gauge bar and right squaring arm
- Shadow light and line for positioning on scribed line
- Rear sliding tray for ease of collecting cutoff materials
- Full length cage type safety guard
- Nylon padded pressure controlled material hold downs
- Movable pedestal with foot control switch and emergency stop
- Rapid precision manual blade clearance adjustment

**QUALITY COMPONENTS AND STRUCTURAL DESIGN:**

- SIEMENS programmable logic controller integrates hydraulic, electrical and CNC controls in one compact module for long-lasting reliable performance
- SIEMENS display screen with foil button controls
- SIEMENS frequency back gauge drive controller
- North-American made pump and back gauge control motors
- North-American standard hydraulic fittings, couplings and hoses
- Field serviceable hydraulic and electric systems
- Swing beam design for consistent precision cutting quality with low maintenance
- Fully hardened sectional upper and lower cutting blades. Bottom blade has four cutting edges, top blade has two
- Low-rake cutting angle for minimum material distortion
- Heavy-duty design, rigid stress relieved box construction

**SPECIFICATIONS**

Models	Capacity Mild steel	Cutting Length	Throat Depth	Back Gauge	Front Gauge	Rake Angle	Motor	Weight Lbs.	Dimensions L x W x H
MSH-08250	1/4"	8'4"	5-13/16"	36"	48"	1° 30'	15HP	14,200	122" x 64" x 65"
MSH-10250	1/4"	10'6"	5-13/16"	36"	48"	1° 30'	15HP	16,100	154" x 68" x 70"
MSH-12250	1/4"	12'	5-13/16"	36"	48"	1° 30'	15HP	22,000	175" x 70" x 71"
MSH-14250	1/4"	14'	4"	36"	48"	1° 30'	15HP	30,500	160" x 82" x 80"
MSH-16250	1/4"	16'	4"	36"	48"	1° 30'	20HP	39,600	235" x 92" x 80"
MSH-10375	3/8"	10'6"	4"	36"	48"	1° 30'	25HP	25,600	160" x 82" x 81"
MSH-12375	3/8"	12'	4"	36"	48"	1° 30'	25HP	28,500	194" x 82" x 81"
MSH-10500	1/2"	10'6"	8"	36"	48"	1° 30'	25HP	29,500	160" x 82" x 84"
MSH-12500	1/2"	12'	8"	36"	48"	1° 30'	30HP	35,200	194" x 96" x 84"
MSH-14500	1/2"	14'	8"	36"	48"	2°	30HP	39,500	160" x 82" x 84"
MSH-16500	1/2"	16'	8"	36"	48"	2°	40HP	61,600	235" x 104" x 100"
MSH-10625	5/8"	10'	8"	36"	48"	2°	50HP	53,000	164" x 94" x 108"
MSH-12625	5/8"	12'	8"	36"	48"	2°	40HP	46,600	196" x 86" x 86"
MSH-10750	3/4"	10'	8"	36"	48"	2° 30'	50HP	53,000	164" x 94" x 108"
MSH-12750	3/4"	12'	8"	36"	48"	2° 30'	50HP	61,000	196" x 96" x 111"

➤ Specifications subject to change without notice ◀



# MASTEEL HYDRAULIC IRON WORKER



## STANDARD CONTROL FEATURES

### HIGHLIGHT FEATURE:

- North-American made pump and motors
- North-American built hydraulics
- North-American built electrics
- Double cylinder operation
- 2 foot pedals for punching side and shearing section
- Adjustable stroke

## OPERATING STATIONS

### PUNCH STATION:

- Universal die block for punching of large flats, angle & channel / beam flanges
- Quick change punch holder, ring and adapters
- Swing away punch stripper with view window
- Punch table with scale and two adjustable gauging stops
- Bending attachment with punch and multi-die as Optional equipment



### SHEARING STATION:

- Shearing stations back gauge w/touch & cut feature
- Adjustable hold down for all shearing section stations
- 90° and 45° angle bar shearing station
- Various size square and round bar shear
- 15" square arm with scale for flat bar shearing station



### NOTCHING STATION:

- Notching table with scale and 3 adjustable gauging stops
- Special design clearance for cutting angle and flat bar
- Electrical locked safety guard

SPECIFICATIONS	MIWH-66	MIWH-90	MIWH-130	MIWH-180
Punch Tonnage (Ton)	66	90	130	180
Max Punch Capacity (Diameter x thickness)	1" x 9/16"	1-1/4" x 3/4"	1-3/8" x 1"	1-7/16" dia. x 1-1/4"
Throat Depth	12"	14"	16" Optional 20"	24"
Flat Bar Shearing (Thickness x Width)	3/4" x 10" 9/16" x 14"	3/4" x 13-1/4" 1/2" x 19"	1" x 13-1/4" 5/8" x 24"	30"x3/4" 16"x1-1/8"
Angle Bar Shear	5" x 5" x 1/2" @ 90°	5.5" x 5.5" x 1/2" @ 90°	6" x 6" x 9/16" @ 90°	8" x 8" x 3/4" @ 90°
Round Bar Shear	1-3/4"	2"	2-3/8"	2-1/4"
Square Bar Shear	1-9/16"	2"	2" x 2"	2-1/4"
Notching	2" x 3-1/2"x5/16"	2-1/4"x 3-7/8" x 1/2"	2-1/2" x 3-7/8" x 1/2"	2-1/2" x 3-1/2"x5/8"
Main Motor	7-1/2 HP	10HP	10HP	20HP
Weight Lbs.	3360	4200	10080	11,000
Dimensions L x W x H	76" X 30" X 70"	78" X 32" X 76"	94" X 38" X 83"	106" X 41" X 91"

**Note:** Capacities based on material with tensile strength of 60,000 PSI. Specifications subject to change without notice

# MASTEEL MANUAL AND CNC PLATE ROLLS

## LHF/E and LHF/SH 3 Roll Initial-Pinch Plate Bending Rolls

### ■ Bending capacity

- ▶ LHF/E (electric drive): 10Ga. -1/4" thickness, 3' -10' length
- ▶ LHF/SH (hydraulic drive): 1/4" -5/8" thickness, 5' -10' length



## LHF/H Hydraulic Double-Pinch 3 and 4 Roll Plate Rolls

### LHF/H Hydraulic Double-Pinch 3 Roll Plate Rolls

- Bending capacity 1/4" -2" thickness, 6' -20' length

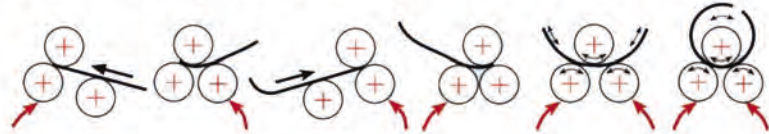

27

### LHF/H Hydraulic Double-Pinch 4 Roll Plate Rolls

- Bending capacity 1/4" -2" thickness, 6' -12' length

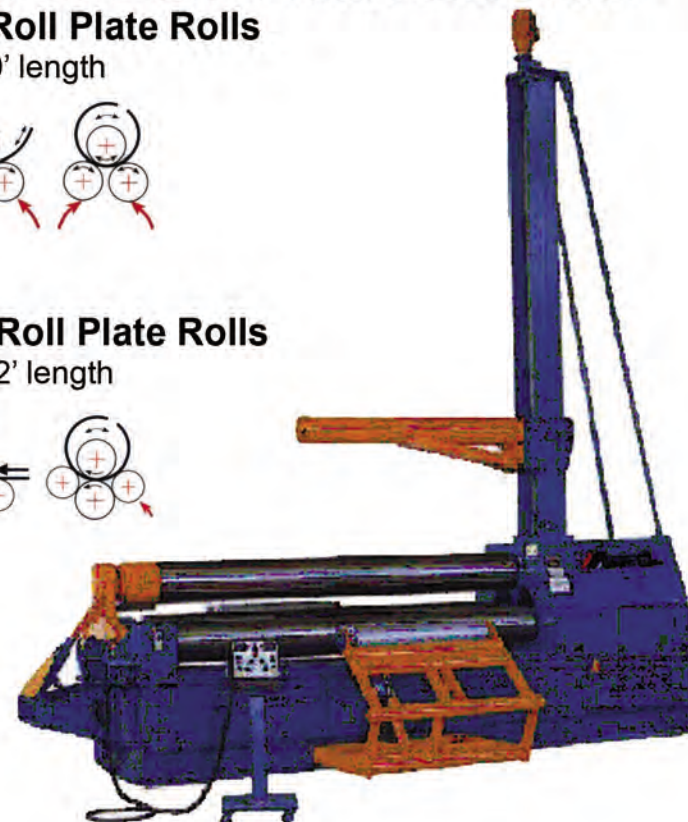

## MASTEEL CNC PLATE ROLL CONTROL FEATURES:

### ESA CNC S630 Control

- 10" touch screen with powerful graphic function
- 1024 x 600 pixels resolution screen display.
- 128 MB silicon disk, 2 USB (2.0) ports.
- Interactive 2D graphic editor for work-pieces and roll data entry
- 2D graphic display of machine frame, work-piece and rolls

- Easy to program bending job and edit bending profile

- Detail display for auto bending

- Roll bending Position display

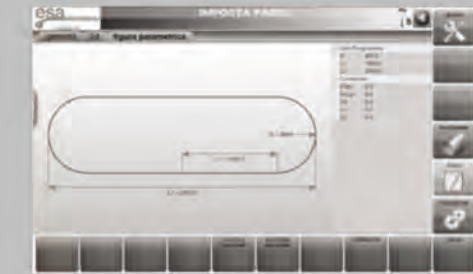
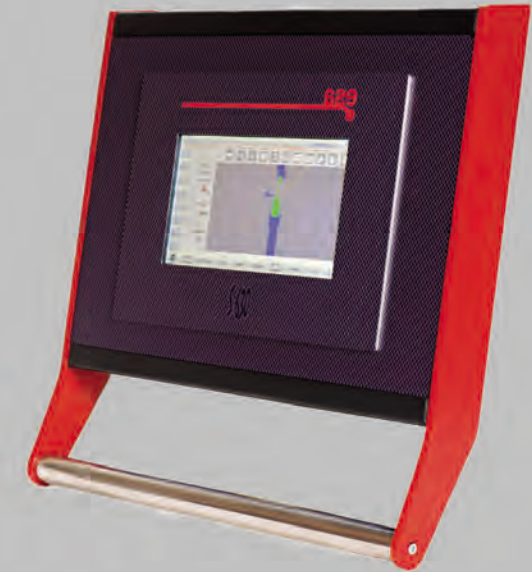

NOTE:

DISTRIBUTOR



Lined area for notes on the left side of the page.

Lined area for notes on the right side of the page.